

SCOREMASTER

The Ultimate Aluminum Sports Goals



Aluminum Construction

- 1/3 the weight of steel.
- Will not corrode.
- Lower maintenance and longer life expectancy.
- Easy to move.
- Reduces field damage.

Engineering Excellence

- High strength TIG welded construction.
- Large section extrusions and custom shapes for structural strength.
- Slide and bolt together connections.

Safety

- Scoremaster goals meet all safety standards when safety instructions (affixed to each goal) are followed.
- Permanently attached net fasteners have a smooth profile, and non protruding bolts and fasteners help prevent injuries.

Quality Control

- Constructed to rigid in-house ISO9000 standard quality control.

Durable Powder Coat Finish

- Baked-on Powder Coating is done in-house.
- Excellent visibility, low maintenance, high weather-resistance and attractive appearance.

Customer Support

- Five-year warranty.
- Extensive dealer support.
- Online help desk.

Experience

- Scoremaster has over twenty-five years of goal-building experience and a dedicated engineering department.
- Extensive product testing and computerized design.
- Scoremaster is owned by Professional Components Ltd., manufacturers of Shockwave Seats for Military, Coast Guard and recreational boaters.

Features & Benefits	3
Mini Soccer Goals	4
Movable Soccer Goals	6
Permanent Soccer Goals	8
Combination Goals	10
Rugby Goalposts	11
Football Goalposts	12
Field Hockey Goals	14
Combination Goals	16
Lacrosse Goals	18
Options & Accessories	19



Mini Soccer Goals | For Under 6 and Under 8

SM-DM600 • SM-DM1000

Scoremaster mini soccer goals for U-6 and U-8 deliver professional-grade strength and quality, with TIG welded aluminum construction built to withstand years of active play.

Specifications

- One-piece, smooth profile, TIG welded goal ends
- Two goals per set. Each goal ships broken down into four easy-to-assemble major components
- Weld joints are reinforced with a doubler plate for extra strength
- Uprights and upper crossbars are made from 4 1/2" X 2" D profile x .100 to .156" variable wall, oval, high strength, aluminum tube
- Deep Net Racks are made from 2" x 3" oval tube x .156" wall (SM-DM1000) and 1.9" OD x .145" wall (SM-DM600), high strength, aluminum pipe for strength and stability
- Auger style ground anchors
- Tether cables for anchoring and storage goal ends
- Tamper-resistant stainless steel hardware
- Rear crossbars are made from 2" x 3" x .156" wall (SM-DM1000) and 1.9" OD x .145" wall (SM-DM600) high strength oval aluminum tube for strength and stability
- This goal is exempt from the requirements of ASTM F2673. Goals exceed all international safety and games standards. All movable goals must be anchored
- Available in white powder coat or aluminum finish
- Five year warranty



The Only TIG Welded Goals in the World

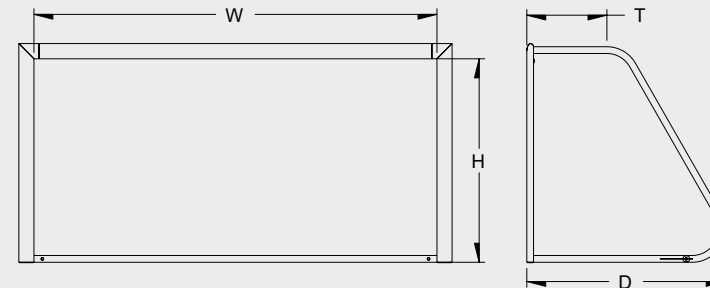
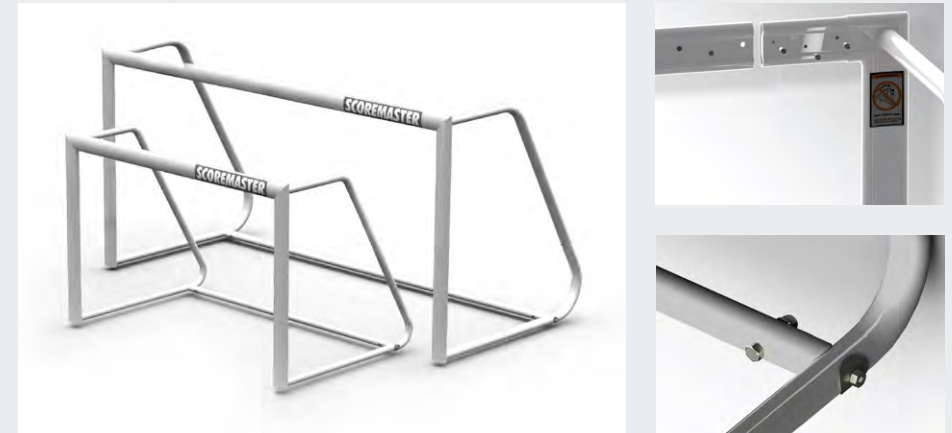

Options

- SM-GT1000 - Permanent Goal Tether – embeds in field for quick anchoring
- SM-SB1000 - Sand Bags – prevents goals from sliding
- SM-GC - Goal Cart System – Four carts per set with two small two-wheel carts slip under goal for easy moving
- SM-DM-WHEEL – Retractable fixed wheel system. Four per set, two or four wheels per goal
- Nets available in heavy-duty (white) or regular (orange)

Model	Net Options	Colour	W	H	D	T	Weight
SM-DM600	SM-REG-NET-DM60-PKG	Orange	6'	4'	4'	2'	55lbs
	SM-HD-NET-DM60-PKG	White					
SM-DM1000	SM-REG-NET-DM10-PKG	Orange	10'	5'	5'	2'	72lbs
	SM-HD-NET-DM10-PKG	White					

Movable Soccer Goals | For Under 11 and Up

SM-DM1200 • SM-DM2400

The Only TIG Welded Goals
in the World

Our movable soccer goals for U-11 and up — engineered with TIG welded aluminum for exceptional strength, durability, and long-lasting performance on the field.

Specifications

- One piece, smooth profile, TIG welded goal ends
- Two goals per set. Each Goal ships broken down into four easy-to-assemble major components
- Weld joints are reinforced with a doubler plate for extra strength
- Uprights and upper crossbars are made from 4 ½" X 4" D profile x .100 to .156" variable wall, oval, high strength, aluminum tube
- Deep net racks are made from 2" x 3" x .156" wall, high strength, oval aluminum tube for strength and stability
- Rear crossbars are made from 4 ½" x 2" D profile x .100 to .156" wall
- high strength oval aluminum tube for strength and stability
- Auger style ground anchors
- Tether cables for anchoring and storage
- Tamper resistant stainless steel hardware
- Meets ASTM Designation F2056 and F2673
- Goals exceed all international safety and game-standards
- Available in white powder coat or aluminum finish
- Five year warranty

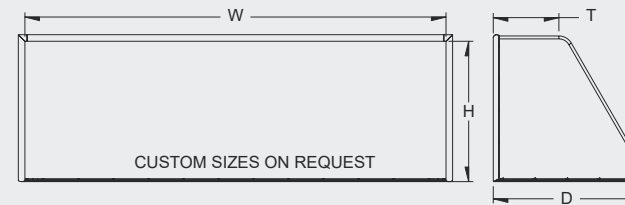
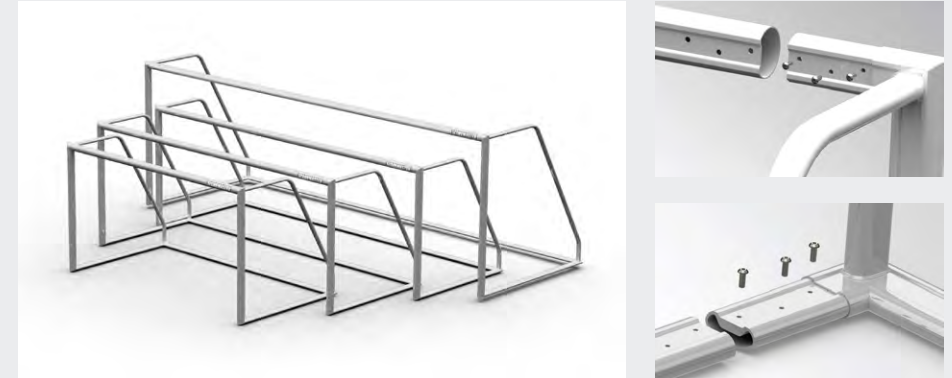

Options

- SM-GT1000 – Permanent Goal Tether – Embeds in field for quick anchoring
- SM-SB1000 – Sand Bags – Goal counter weight
- SM-GC – Goal Cart System – four carts per set with two wheel carts slip under goal for easy moving
- SM-DM-WHEEL – Retractable fixed wheel system. Four per set, two or four wheels per goal
- Nets available in heavy-duty (white) or regular (orange)

Model	Net Options	Colour	W	H	D	T	Weight
SM-DM1200	SM-REG-NETDM12-PKG	Orange	12'	6'6"	6'10"	3'	140lbs
	SM-HD-NET-DM12-PKG	White					
SM-DM1600	SM-REG-NETDM16-PKG	Orange	16'5"	6'7"	6'10"	3'	150lbs
	SM-HD-NET-DM16-PKG	White					
SM-DM1800	SM-REG-NETDM18-PKG	Orange	18'6"	6'6"	6'10"	3'	155lbs
	SM-HD-NET-DM18-PKG	White					
SM-DM2100	SM-REG-NETDM21-PKG	Orange	21'	7'	7'4"	3'	162lbs
	SM-HD-NET-DM21-PKG	White					
SM-DM2400	SM-REG-NETDM24-PKG	Orange	24'	8'	8'4"	4'	180lbs
	SM-HD-NET-DM12-PKG	White					

Permanent Soccer Goals

SM-P1800 • SM-P2100 • SM-P2400

Scoremaster permanent soccer goals are built for long-term performance, with fully TIG welded aluminum construction that delivers unmatched strength, durability, and safety year after year.

Specifications

- One piece, smooth profile, TIG welded construction
- 2 goals per set. Each goal ships broken down into 3 easy to assemble major components
- Uprights and upper crossbars are made from 4 ½" x 4" D profile x .100 to .156" variable wall, oval, high strength, aluminum tube
- Optional football and rugby uprights are 3½" and 2½" heavy wall aluminum tubing
- Tamper resistant stainless steel hardware
- Goals exceed all international safety and games standards
- White powder coat finish is standard
- Five year warranty

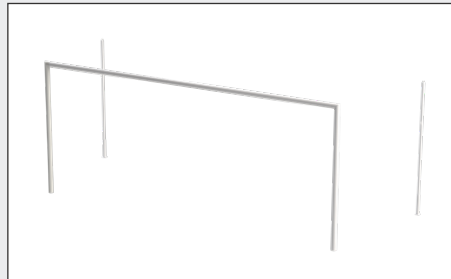

SM-PRO-Stanchions Professional box style net backstays

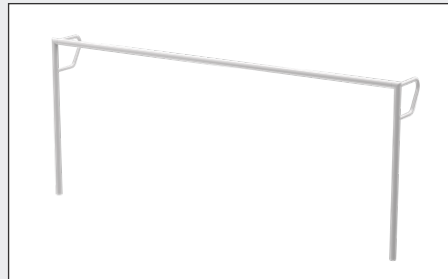

SM-NR000 European Style Net Racks - "P" style net rack



The Only TIG Welded Goals in the World



Options

- SM-NR000 European style net racks – "P" Style net rack.
- SM-PRO-STANCHIONS Professional box style net backstays.
- SM-P2400C-CDN combination soccer, football and rugby goal.
- SM-GT1000 – Permanent Goal Tether – Embeds in field for quick anchoring
- SM-SB1000 – Sand Bags – Goal counter weight
- SM-GC – Goal Cart System – 4 carts per set with 2 wheel carts slip under goal for easy moving
- SM-DM-WHEEL – Retractable fixed wheel system. Four per set, two or four wheels per goal
- Nets available in heavy-duty (white) or regular (orange)

Net Options			Colour		
SM-REG-NET-P24-PKG	Regular Duty Net	3mm	Twisted	Orange	
SM-HD-NET-P18-PKG to SM-HD-NET-P24-PKG	Heavy Duty Net	4mm	Braided	Orange	
SM-HD-NET-P2400PRO-PKG	Heavy Duty Net for PRO style goal	4mm	Braided	White	
SM-REG-NET-DM24-PKG	Regular Net for Euro P style goal	3mm	Twisted	Orange	
SM-HD-NET-DM24-PKG	Heavy Duty Net for Euro P style goal	4mm	Braided	White	

Model	W(1)	W(2)	H(1)	H(2)	Weight
SM-DM2400	24'		8'		89lbs
SM-DM2100	21'		7'		68lbs
SM-DM1800	18'6"		6'6"		77lbs
SM-DM2400 PRO	24'		8'		119lbs
SM-DM2400C-CDN	24'	18'6"	8'	10'	150lbs

Canadian model (CDN) includes uprights for Rugby/Canadian Football.

Futsal Goals

SM-F1100

The Only TIG Welded Goals in the World

Scoremaster futsal goals are built for indoor play with the same TIG welded aluminum strength as our outdoor models. Durable, stable, and floor-safe – perfect for gyms and high-level futsal.

Specifications

- One piece, smooth profile, TIG welded goal ends
- Two goals per set. Each goal ships broken down into three easy to assemble major components. Easy to store.
- Welded joints are reinforced with a doubler plates for extra strength
- Uprights and upper crossbars are made from 4 ½" x 2" D profile x .100 to .156" variable wall, oval, high strength, aluminum tube
- Heavy rubber base pads
- Deep net racks are made from 1.9" OD x .145" wall, high strength, aluminum pipe for strength and stability
- Tamper resistant stainless steel hardware
- Goals exceed all international safety and games standards
- Available in white powder coat finish
- Five year warranty

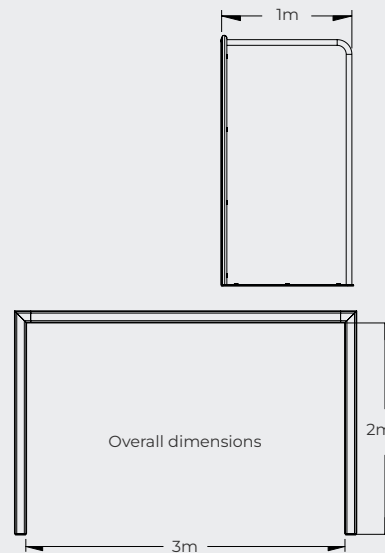
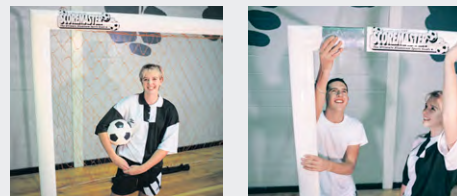

Model	Net Options	Colour	W	H	D	Weight
SM-F1100	SM-HD-NET-F11-PKG Heavy-duty net 3.5mm	Braided Orange	3m	2m	1m	65lbs

Rugby Goalposts

SM-R1000

The Only TIG Welded Goals in the World

Scoremaster rugby goals are made in Canada with rugged TIG welded aluminum construction for unmatched durability. Aluminum ground sleeves allow seasonal removal of goalposts. Custom heights and colours are available.

Specifications

- Strong through bolted construction
- Two goalposts per set. Each goalpost ships broken down into five easy to assemble major components. Easy to assemble and store
- Aluminum ground sleeves
- Aluminum ground safety caps to cap ground sleeves when goals are not installed
- Lower Uprights are made from 3 ½" OD x .216" wall, high strength, aluminum pipe
- Stainless steel hardware
- Crossbars and upper upright extensions are made from 2.875" OD x .203" wall, high strength, aluminum pipe
- Goals exceed all international safety and games standards
- Available in white powder coat or aluminum finish
- Five year warranty

Options

- Custom heights are available
- SM-R1000-PAD Safety Pads
- Custom logos and identification on padding
- SM-PENNANT - Wind direction pennants

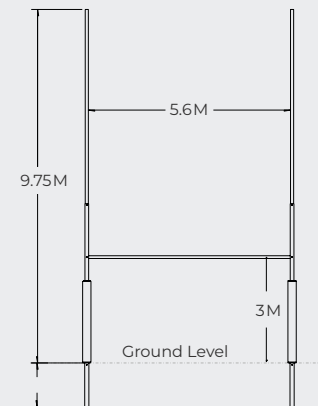

Dimensions shown are standard. Custom sizes and paint schemes are available on request.

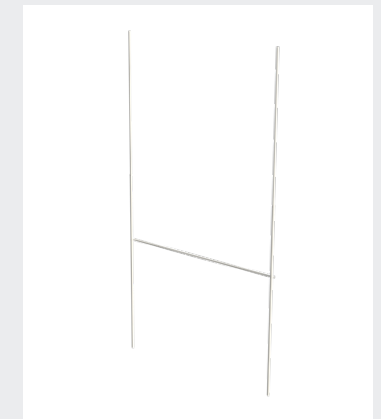

Football Goalposts

SM-FB1000CDN-PC-72 • SM-FB1000USA-PC-102

Scoremaster Football Goalposts are professional quality goalposts for professional play. Featuring welded aluminum heavy wall pipe construction. 1/3 the weight of steel posts, aluminum goalposts are easier and safer to install or disassemble.

Specifications

- One-piece, smooth profile, MIG welded goal construction
- Ships broken down into four major components
- Welded joints are reinforced for extra strength
- Goosenecks and crossbars are made from 6.63" OD x .280 wall high strength, aluminum pipe
- Galvanized steel ground sleeves with aluminum safety caps
- Uprights are made from 3" OD x .125" wall, high strength, aluminum tube with wind tether eye ring welded to tops
- Stainless steel hardware
- Goalposts exceed all international safety and games standards
- Available in yellow or white powder coat finish
- Available in custom offsets
- Five year warranty

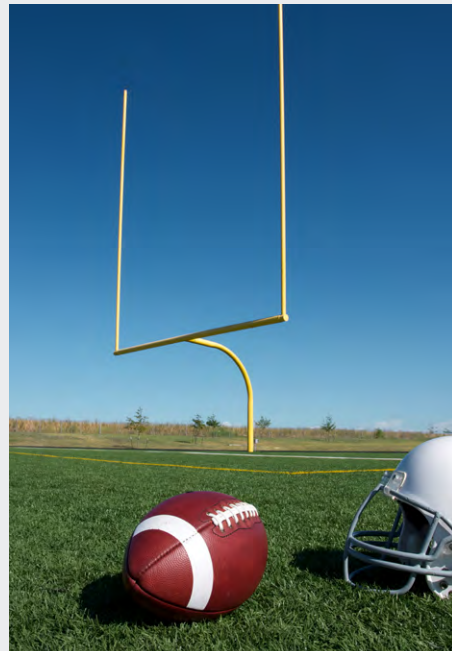

The Only TIG Welded Goals in the World

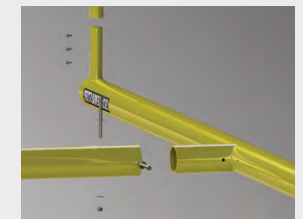
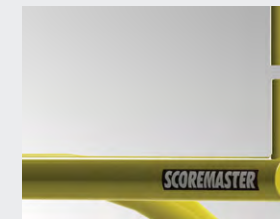
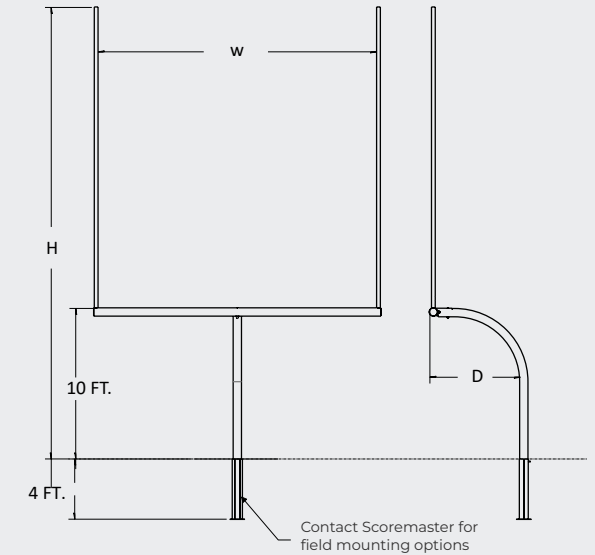

Options

- SM-FB1000-RB, Recess box
- SM-FB-PAD Football Pad available in a variety of colours
- Custom logos and identification available for pads
- Available in custom offsets

Model	W	H	D	T	Weight
SM-FB1000CDN-PC-72	18'6"	30'	6'	2'	279lbs
SM-FB1000CDN-PC-102	18'6"	30'	5'	8'6"	300lbs

Field Hockey Goals

SM-FH1200

Scoremaster field hockey goals are proudly made in Canada with fully TIG and MIG welded aluminum construction. Built tough with heavy rubber backboards, they're designed to withstand years of intense play.

Specifications

- One-piece, smooth profile, TIG and MIG welded goal-ends
- Each goal end ships broken down into four major components. Easy to assemble and store
- Weld joints are reinforced with a doubler plate for extra strength
- Uprights and upper crossbars are made from 2 x 3" x .125" wall, high strength aluminum tube
- Heavy duty rubber backboards
- Goals exceed all international safety and games standards
- Deep net racks are made from 1.9" OD x .145" wall, high strength aluminum pipe for strength and stability
- Stainless steel hardware
- Available in orange powder coat finish
- Five year warranty



The Only TIG Welded Goals in the World

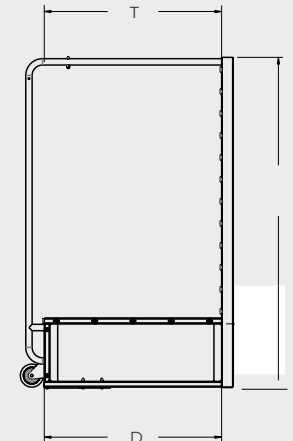
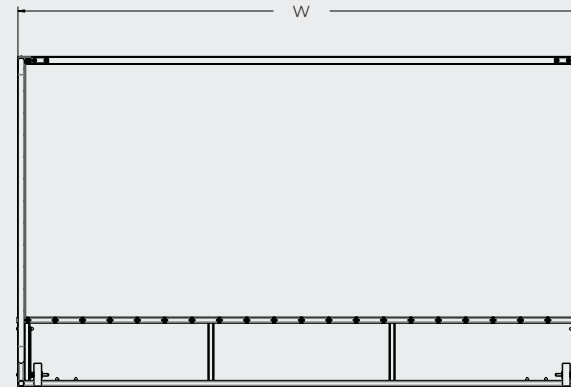

Options

- SM-FH1200-WHEELS Wheel system attaches to the goal to allow it to be moved easily

Model	Net Options	W	H	D	T	Weight
SM-FH1200	SM-REG-NET-DM60-PKG	3m	2m	1m	1m	180lbs

Combination Goals

SM-DM1200 • SM-DM2400

Ideal for multi-purpose sport fields, our Combination Goals feature full specification permanent soccer goals, with upright goals posts for football and rugby.

Specifications

- One piece, smooth profile, TIG welded construction.
- Two goals per set. Each goal ships broken down into easy to assemble major components.
- Uprights and upper crossbars are made from 4 ½" x 4" D profile x .100 to .156" variable wall, oval, high strength, aluminum tube.
- Tamper-resistant stainless steel hardware.
- Football and rugby uprights are 3½" and 2 ½" heavy wall aluminum tubing.
- Flush style net hooks.
- Goals exceed all international safety and games standards.
- Available in white powder coat or aluminum finish.
- Five year warranty.



The Only TIG Welded Goals in the World

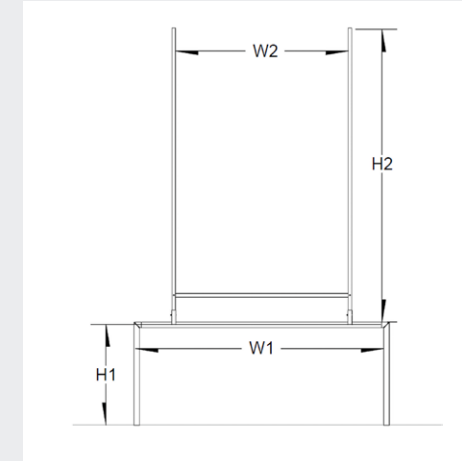

Options

- SM-P2400-PC – White powder coat finish – our own in-house high quality.
- SM-NR000 European style net racks – “P” Style net rack.
- Custom heights are available.
- SM-R1000-PAD Safety Pads.
- Custom logos and identification.
- SM-PENNANT – Wind direction pennants.

Net Options				Colour
SM-REG-NET-P24-PKG	Regular Duty Net	3mm	Twisted	Orange
SM-HD-NET-P16-PKG to SM-HD-NET-P24-PKG	Heavy-duty Net	4mm	Braided	Orange
SM-NR1000 option uses SM-REG-NET-DM24-PKG or SM-HD-NET-DM24-PKG				

Model	W	H	D	T	Weight
SM-P2400C-CDN	24'	18'6"	8'	10'	150lbs

Lacrosse Goals

SM-L1000

The Only TIG Welded Goals in the World

Scoremaster lacrosse goals are proudly made in Canada with precision TIG welded aluminum construction. Built for strength, stability, and long-term performance — trusted by teams at every level.

Specifications

- Ships broken down into two easy to assemble major components. Easy to assemble and store
- Uprights and upper crossbars are made from 1.66' OD x .140 wall, high strength, aluminum tube
- Stainless steel hardware
- Goals exceed all international safety and games standards
- Available in orange powder coat finish
- Five year warranty

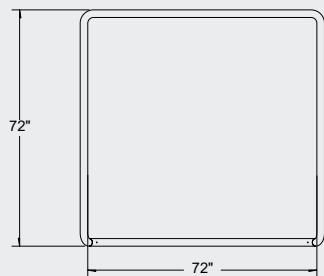
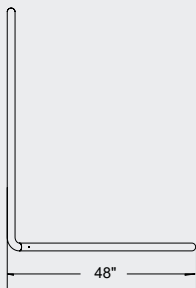

Model	W	H	D	T	Net Options	Colour
SM-L1000	72"	72"	4"	4'	SM-HD-NET-L10 Heavy-duty net 3mm Braided	Black

Options & Accessories



SM-DM-WHEEL Wheel System

This is a bolt-on retractable wheel system. Four wheels and retractors are included in the package.



SM-GC Goal Cart

This is a bolt-on or slip-on system. Four wheels slide under the goal and can be removed after the goal is moved. One set of four will move multiple goals as they are not permanently attached.



SM-SB1000 Sand Bag

Sandbags stop goals from sliding and/or tipping.



SM-GT1000 Goal Tether

This is a permanent goal tether that can be buried into the field for quick anchoring of goals. The Goal Tether allows you to remove the goal when not in use or lock it down when in use.



SM-R1000-PAD or SM-FB-PAD Football or Rugby Pads

Rugby/Football goal pads prevent injuries to players and slip over the goal base in minutes.



SM-FH1200-WHEELS Field Hockey Wheel System

Field Hockey wheels are permanently attached and allow Field Hockey Goals to be moved easily.



SM-Pennant Wind Direction Pennant

Wind Direction Pennants can be attached to the goal by carabiner.

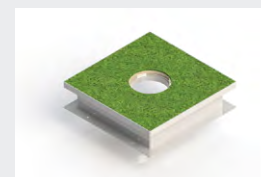

SM-FB-1000 Mounting box

Made to mount Football goals on artificial turf. It is just one example of the many custom mounting solutions that Scoremaster can provide.



SM-VELCRO Velcro fasteners

Velcro net fasteners are standard on all goals. Sold twelve per package. Teamed up with our stainless steel net fasteners — installing and removing nets is a breeze.

SCOREMASTER



The Ultimate Aluminum Sports Goals

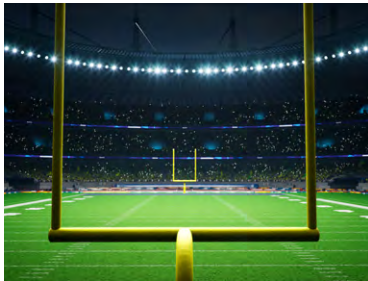

**A Proud 30 Year History of Building
the Finest Aluminum Sports Goals Worldwide.**



SOCCER • RUGBY • FOOTBALL • FIELD HOCKEY • LACROSSE

 www.scoremastergoals.com  1.888.726.7627  2074 Henry Avenue, Sidney BC Canada V8L 5Y1